

Двухступенчатый угловой мотор-редуктор SPN06 R2

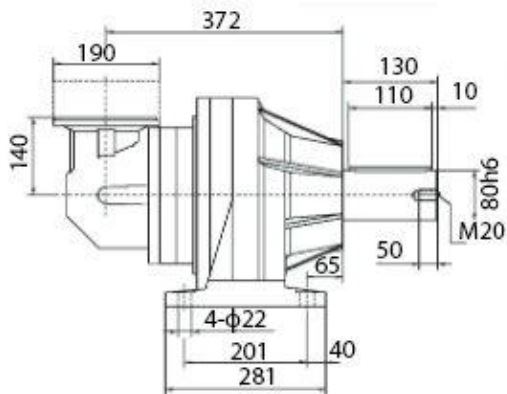

PC

PZ

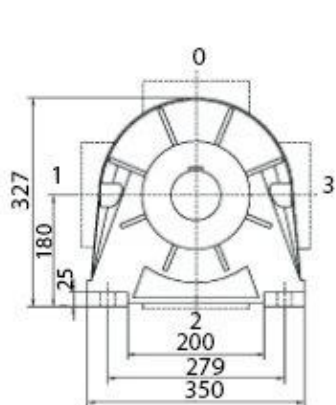
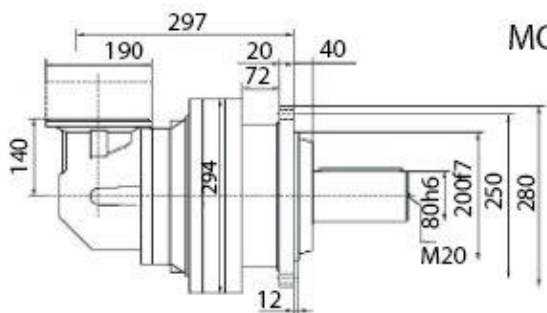
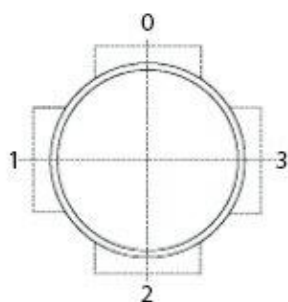
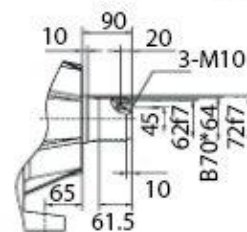

MC

MZ

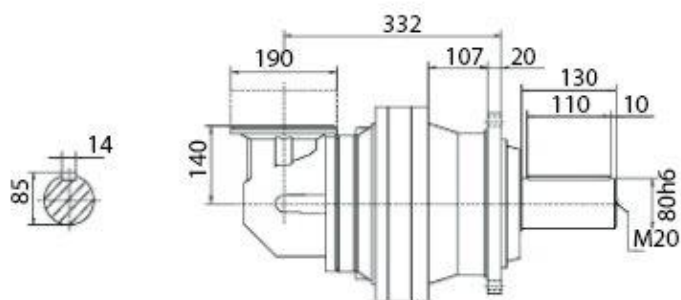
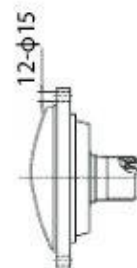

HC

HZ

FZ



Shrink disc

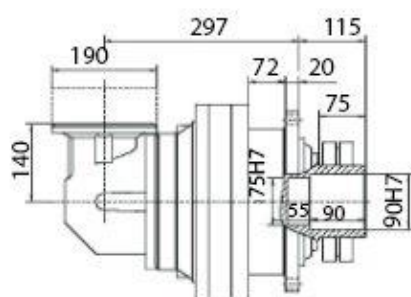
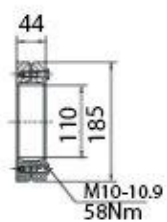

FP

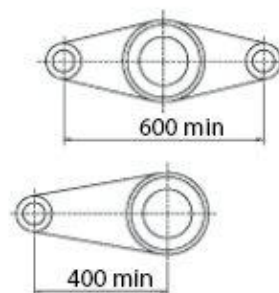



Трехступенчатый угловой мотор-редуктор SPN06 R3

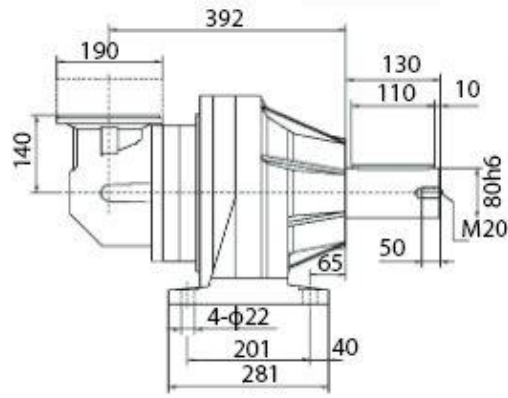
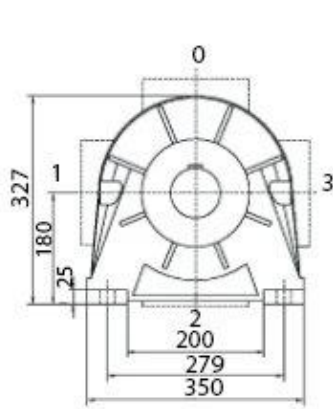

PC

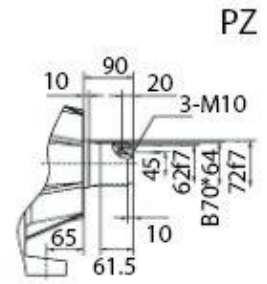

PZ

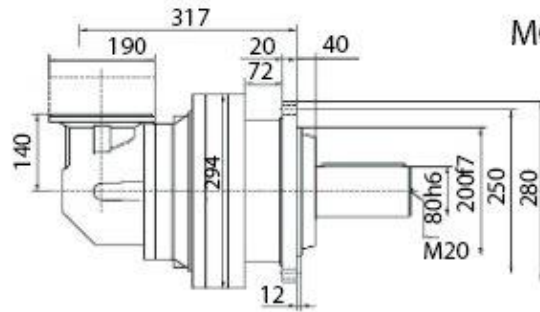
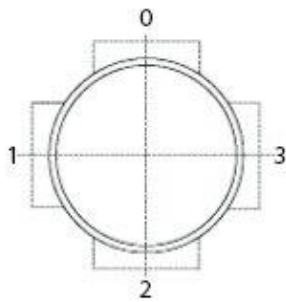

MC

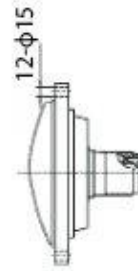

MZ

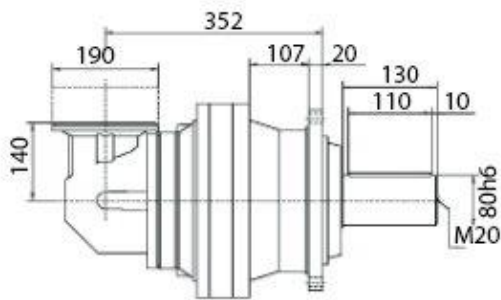
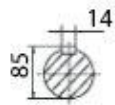

HC



HZ



FZ

Shrink disc

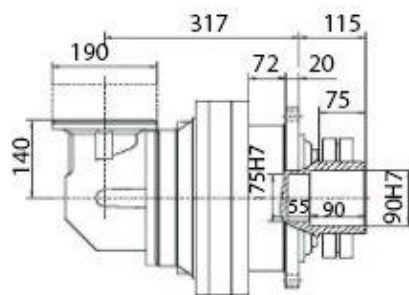
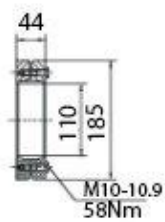

FP

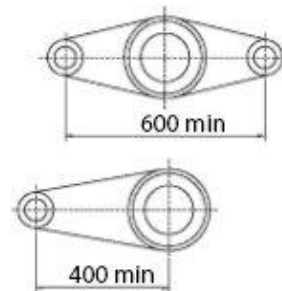

Четырехступенчатый угловой мотор-редуктор SPN06 R4

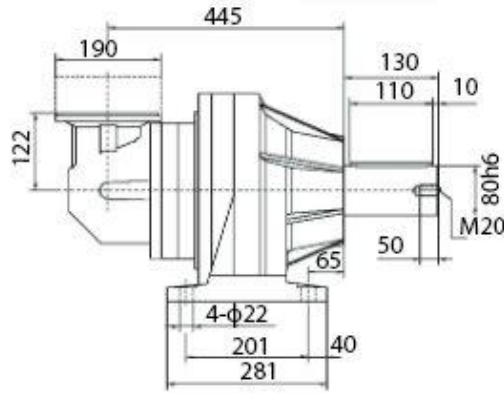
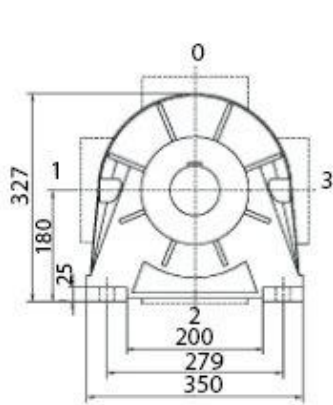

PC

PZ

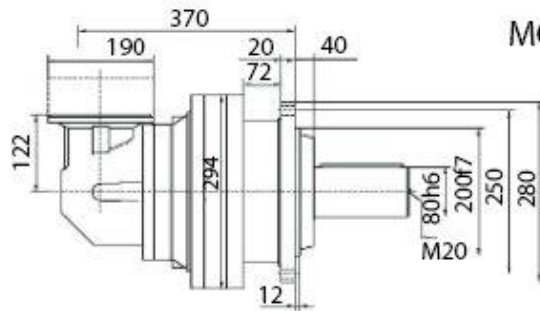
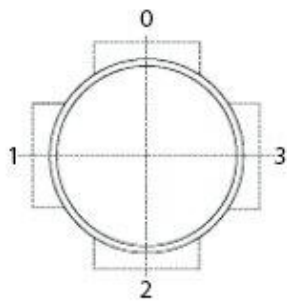
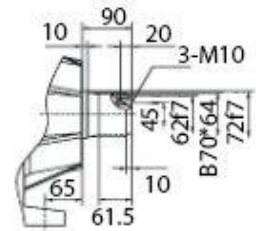

MC

MZ

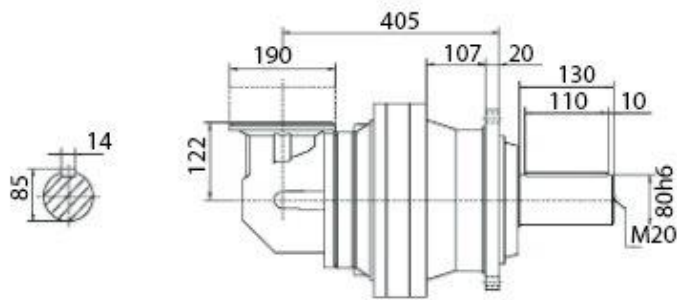
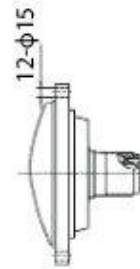

HC

HZ

FZ

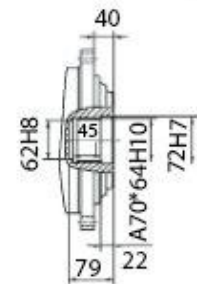

Shrink disc

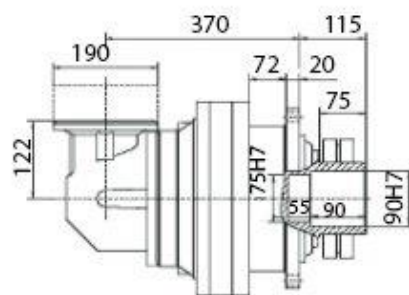
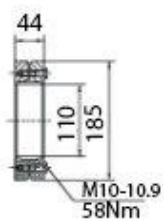

FP

