

NERIDRIVE Manual

 **NERIMOTORI**
Experience the power



INSTALLATION AND USER MANUAL

TABLE OF CONTENTS

1. INTRODUCTION	3
1.1 FIELD OF APPLICATION	3
1.2 SAFETY	3
1.3 EU DECLARATION OF CONFORMITY	3
2. DESCRIPTION OF THE PRODUCT	4
2.1 DIMENSIONS.....	4
2.2 CHARACTERISTICS	4
2.3 VERSIONS.....	5
2.4 PRODUCT IDENTIFICATION AND RATING PLATE	5
3. ASSEMBLING THE MOTOINVERTER	6
3.1 MECHANICAL INSTALLATION OF THE INVERTER ON THE MOTOR	6
3.2 ELECTRICAL CONNECTION BETWEEN INVERTER AND MOTOR	6
4. ELECTRICAL CONNECTION	7
4.1 SAFETY	7
4.2 POWER SUPPLY	7
4.3 FIRST ENERGISATION	7
4.4 EMC PROTECTION	8
4.5 REMOVAL AND OPERATIONS WITH CASING OPEN	8
5. CONTROL	9
5.1 CONNECTION DIAGRAMS	9
5.2 KEYPAD CONTROL	12
5.3 DIGITAL INPUTS CONTROL.....	12
5.4 ANALOGUE INPUT CONTROL.....	14
5.5 MODBUS CONTROL.....	14
5.6 DIGITAL PROGRAMMING TERMINAL ALS1	15
5.7 REMOTE CONTROL TERMINAL ALS3	16
5.8 PROGRAMMABLE DIGITAL OUTPUTS.....	16
5.9 SPECIAL OPERATING MODES.....	17
6. PARAMETERS	17
6.1 LIST OF PARAMETERS.....	17
6.2 GROUP OF "S" PARAMETERS.....	19
6.3 GROUP OF "P" PARAMETERS	21
6.4 GROUP OF "F" PARAMETERS.....	24
6.5 GROUP OF "A" PARAMETERS	24
6.6 GROUP OF "I" PARAMETERS.....	25
6.7 GROUP OF "O" PARAMETERS	25
6.8 GROUP OF "d" PARAMETERS.....	26
7. APPLICATION EXAMPLES	27
7.1 "4 SPEEDS" MODE	27
7.2 "2 + 2 SPEEDS" MODE	27
7.3 "8 SPEEDS" MODE	28
7.4 RECIPROCATOR MODE.....	28
7.5 SELF-HOLD MODE	29
8. DIAGNOSTICS AND TROUBLESHOOTING	29
8.1 VIEWING ERRORS AND PROTECTION DEVICES.....	29
8.2 RESETTING THE ERRORS AND PROTECTION DEVICES	29
8.3 PROTECTION DEVICE INTERVENTION	30
9. LOAD CURVE	31
10. ACCESSORIES	32
11. DISPOSAL	33

1. INTRODUCTION

1.1 FIELD OF APPLICATION

- This manual applies to the following Motoinverter models: NERIDRIVE Junior, NERIDRIVE Small, NERIDRIVE Medium single-phase, NERIDRIVE Medium three-phase, NERIDRIVE Big single-phase, NERIDRIVE Big three-phase, NERIDRIVE Premium.
- The Motoinverter are designed and built to run, in accordance with the rating plate, in environments with a temperature between 0 °C and 40 °C and a maximum altitude of 1000 m above sea level.
- Use the Motoinverter only for the applications for which it was designed. Respect plate specifications. Failure to follow the instructions in this manual and the reference standards could make the Motoinverter unsuitable for use.

1.2 SAFETY

- The installation, maintenance and disposal of the Motoinverter must be carried out by qualified personnel, in compliance with the regulations in force, after having read this use and maintenance manual.
- The Motoinverter consists of a rotating electric machine, with moving parts. The motor can reach high temperatures.
- Any work on the Motoinverter must be performed when the machine is stopped and disconnected from the mains.
- The Motoinverter is intended to be incorporated in other equipment or machinery and must never be put into operation unless the equipment or machinery complies with the Machinery Directive, as provided for in Annex II B) of Directive 2006/42/EC.
- The Motoinverter is not suitable for being powered by an AC generator.
- IT IS FORBIDDEN to use the motor in environments with conditions other than those specified "IP" on the rating plate.
- IT IS FORBIDDEN to start the Motoinverter without a shaft cover because the spline could be ejected dangerously due to centrifugal force as laid down in EN 60204-1.

1.3 EU DECLARATION OF CONFORMITY

Declaration of Conformity downloadable from the manufacturer's website.

2. DESCRIPTION OF THE PRODUCT

2.1 DIMENSIONS

Model	Size	SD mm	LC mm	LL mm	LH mm	PG1	PG2
JUNIOR	56	113	125	195	60	PG11	2xPG9
	63	125	125	195	60	PG11	2xPG9
	71	143	125	195	60	PG11	2xPG9
SMALL	63	146	125	195	78.5	PG11	2xPG9
	71	156	125	195	78.5	PG11	2xPG9
	80	161	125	195	78.5	PG11	2xPG9
	90	169	125	195	78.5	PG11	2xPG9
MEDIUM single- phase/ three- phase	80	179	150	206	102	PG11	3xPG9
	90	187	150	206	102	PG11	3xPG9
	100	198	150	206	102	PG11	3xPG9
	112	208	150	206	102	PG11	3xPG9
BIG single- phase/ three- phase	80	204	171	261	123.5	PG13,5	3xPG9
	90	212	171	261	123.5	PG13,5	3xPG9
	100	223	171	261	123.5	PG13,5	3xPG9
	112	233	171	261	123.5	PG13,5	3xPG9
	132	252	171	261	123.5	PG13,5	3xPG9
PREMIUM	90	204	208	334	117	PG13,5	3xPG9
	100	215	208	334	117	PG13,5	3xPG9
	112	224	208	334	117	PG13,5	3xPG9
	132	243	208	334	117	PG13,5	3xPG9
	160	272	208	334	117	PG13,5	3xPG9

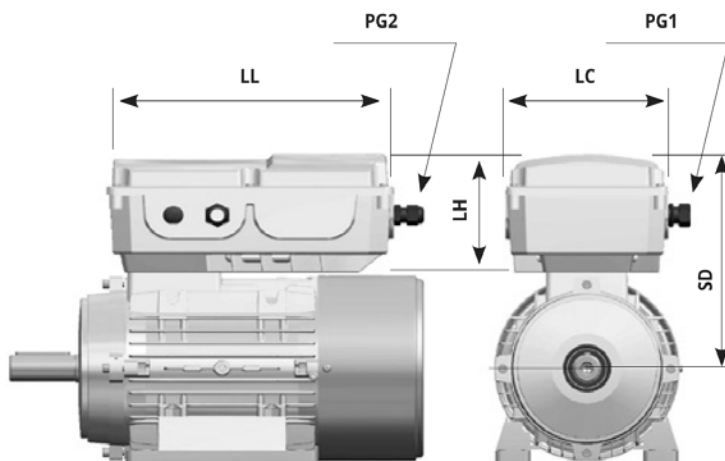

2.2 CHARACTERISTICS

	NERIDRIVE JUNIOR	NERIDRIVE SMALL	NERIDRIVE MEDIUM Single- phase	NERIDRIVE MEDIUM Three- phase	NERIDRIVE BIG Single-phase	NERIDRIVE BIG Three-phase	NERIDRIVE PREMIUM
Power supply	Single-phase 230 V 50 Hz	Single-phase 230 V 50 Hz	Single-phase 230 V 50 Hz	Three-phase 400 V 50 Hz	Single-phase 230 V 50 Hz	Three-phase 400 V 50 Hz	Three-phase 400 V 50 Hz
Voltage [V]	180 - 264	180 - 264	180 - 264	340 - 440	180 - 264	340 - 440	340 - 440
Frequency [Hz]	42 - 60	42 - 60	42 - 60	42 - 60	42 - 60	42 - 60	42 - 60
Power [kW]	Up to 0.18	Up to 0.75	Up to 2.2	Up to 2.2	Up to 3	Up to 4	Up to 7.5
Overload	150%	150%	150%	150%	150%	150%	150%
EMC Class Certificated EN61800	C2/C3*	C2/C3*	C2/C3*	C3	C3	C3	C3
Digital inputs	4	4	6	6	6	6	6
Analogue inputs	1	1	1	1	1	1	1
Digital outputs	1	1	1	2	2	2	2
Serial port RS485	1	1	1	1	1	1	1
Output frequency [Hz]	3 - 159						
Torque	According to motor characteristics						
Type of control Modulation	SVM – Space Vector Modulation PWM – Pulse Width Modulation						
PWM frequency [kHz]	2.5 - 15						
	*For Class C2 has to be assembled a jumper to connect the filter to the PE						

2.3 VERSIONS

Version	Description	Input	Programming
B	Version without keypad	The motor can be controlled by the analogue and digital inputs	Inverter can be programmed by means of Digital Programming Terminal ALS1
T	Version with keypad	The motor can be controlled through the inverter keypad	Inverter can be programmed by means of Digital Programming Terminal ALS1
D	Version with display	The motor can be controlled through the inverter keypad	Inverter can be programmed by means of keypad

Version B 	Version T 	Version D 
---	---	---

2.4 PRODUCT IDENTIFICATION AND RATING PLATE

Voltage, frequency and rated current on the inverter input side

Serial Number and rated power





NERIDRIVE type

CE Marking

3. ASSEMBLING THE MOTOINVERTER

3.1 MECHANICAL INSTALLATION OF THE INVERTER ON THE MOTOR

	ATTENTION: before starting the assembly, make sure the motor plate data are compatible with the specific characteristics of the inverter used (shown on the label of the inverter itself). If you have any doubts, contact our Technical Service.
	If you have purchased a Motoinverter that is already assembled, or you only need to carry out the electrical installation, you don't need to read this paragraph.

- The assembly involves the mechanical coupling of the Motoinverter base box with the motor terminal block cover base, and the preparation of the connection cables between the motor terminals and the inverter tab.
- Check that the size and centre distance of the threaded bores of the base of the terminal block cover on your motor (usually provided with the terminal cover) are suitable for coupling with the flange on the base of the inverter.
- Connect the jumpers in the terminal block according to the inverter's voltage (e.g.: 230/400 V, triangle connection for single-phase 230 V inverter, star connection for 400 V inverter) and then connect the eye terminals (supplied) to the terminal board's pins and tighten the bolts with a suitable tightening torque.
- Respect the appropriate safety distances between the parts, which are live during operation, and the motor's casing (or other neutral parts).
- Position the inverter box base on the motor, threading the three wires (previously connected to the motor terminals) through the central slots on the gasket.
- Thread the three wires through the slot on the printed circuit board so that, when the inverter base has been fixed to the motor, the female faston terminals can be connected to the male faston "U", "V" and "W" of the inverter tab.
- Tighten the screws that fix the inverter base to the motor terminal block base, making sure the gasket is correctly pressed all along the point of contact between the inverter and the motor.
- Make the electrical connection of the inverter tab as described in the next paragraph.

3.2 ELECTRICAL CONNECTION BETWEEN INVERTER AND MOTOR

	If you have purchased a Motoinverter that is already assembled, or you only need to carry out the electrical installation, you don't need to read this paragraph.
---	---

This assembly phase involves the electrical connection between the motor and the inverter tab.

The base of the inverter module box is already coupled with the motor framework, and the eye-terminated wires (motor side) and 6.3 mm female faston (inverter side) are already connected to the motor terminals, as described in the previous paragraph.

Connect the female faston from the motor windings to the connection terminals on the inverter tab (refer to Par 5.1 Connection Diagrams).

If several Motoinverter are assembled in series, it's a good idea to always respect the same phase sequence so that motor rotation directions (defined in this manual as "FORWARD" and "REVERSE") are consistent throughout your entire production.

The three wires are of different colours for this purpose.

	ATTENTION: if separate ventilation with a supply of 24 V DC or 220/380 V AC is envisaged for the motor, please contact our technical office for the details of the electrical connection.
---	---

4. ELECTRICAL CONNECTION

4.1 SAFETY

- It is essential to read this chapter before carrying out the electrical installation of the new Motoinverter or the spare part, or the reinstallation following system maintenance.
- The electric motor should be installed by qualified personnel, adhering to the regulations in force, after having read this use and maintenance manual.
- Aside from the intervention (using suitable tools - a screwdriver with a 3 mm blade) on the connection terminals, carried out while the inverter is de-energised, no other operation is required or allowed on any part of the Motoinverter. The separation of the electronic tab from the upper radiator is not permitted, and any tampering, modification, replacement or removal of any electronic component on the Motoinverter is forbidden.
- The input of the Motoinverter supply cable must be made with a sheathed cable (2 poles plus earth), of a suitable section. The external section of the cable must be circular, and its diameter must be suitable for the cable gland (to ensure the correct grip of the cable gland). No shielding is needed for the supply cable. On the other hand, a correct earth connection is fundamental for electrical safety and EMC protection. For this reason, the PE terminal must be connected to the protection wire located in the control panel.
- At the end of the wiring operations (described in this chapter) and before energising, it is essential to close the inverter cover to guarantee the electrical safety of the system.
- All installation, maintenance and removal operations must be carried out strictly respecting the current "work safety" laws: in fact, the indications provided herein are of a general nature, and cannot consider the specific features of every possible installation. It is therefore essential to fully observe the relevant safety regulations for the specific context. Should there be any inconsistency between the possibility of carrying out an operation described in this manual and work safety regulations (established by the law or by the person in charge of the place where the operations are carried out), compliance with safety regulations must always come first.

4.2 POWER SUPPLY

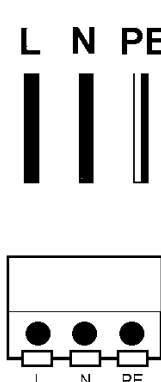
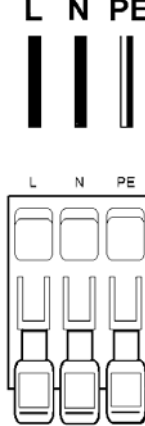
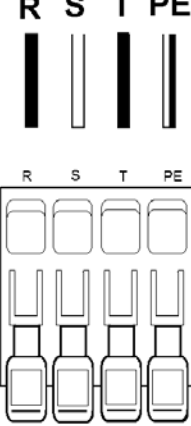
Model	NERIDRIVE JUNIOR NERIDRIVE SMALL	NERIDRIVE MEDIUM Single-phase NERIDRIVE BIG Single-phase	NERIDRIVE MEDIUM three-phase NERIDRIVE three -phase NERIDRIVE PREMIUM
Power supply	Single-phase 230 V 50 Hz	Single-phase 230 V 50 Hz	Three-phase 400 V 50 Hz
Connector	Push-in connector 	Connector with levers 	Connector with levers 

*See connection diagrams Cap 5 number 1.

4.3 FIRST ENERGISATION

Energization is only permitted once the inverter cover has been replaced and the four fixing screws have been tightened. Pay special attention to the correct positioning of the gasket between the cover and the base of the box before tightening the screws.

The initial start-up operations must be carried out only by personnel who have been suitably trained, or who possess the skills and/or professional qualifications needed to work on live systems and moving mechanical parts.

The instructions given in this paragraph concern motor shaft rotation. It is therefore essential to make sure the Motoinverter has already been mechanically fixed to a solid anchor point (if not connected to the mechanical transmission) or can run without damaging the transmission parts or creating hazards for people/animals (if already connected to the transmission's mechanics).

4.4 EMC PROTECTION

The Motoinverter is equipped as standard with a passive filtering stage, and it is certified according standards EN 61800-3 and EN 61000-4. See par 2.2 for EMC class of each model.

To comply the limits envisaged for Class C2 (residential environment), the filtering stage closure jumper must be assembled on the PE (jumper not included).

When the jumper is mounted the leakage current may cause the system's 30mA differential protection devices to be triggered, especially if those devices also cover other electric loads with similar filtering characteristics. In this case, the people in charge of electrical maintenance and safety in the place where the Motoinverter is installed must identify and adopt the most suitable protection measures.



ATTENTION: in any case, the presence of the EMC filter on the Motoinverter tab may trigger, when energized, the differential protection devices if they are not correctly sized.
You are advised to use differential circuit breakers suitable for the supply of loads with EMC filters. The installer can contact our Technical Service if any further information is required.
Never remove the earth wire connected to the PE terminal of the inverter tab to handle any tripping problems of the differential protection device. This would make the installation non-compliant from an electrical safety and EMC protection viewpoint.

4.5 REMOVAL AND OPERATIONS WITH CASING OPEN



ATTENTION - RISK OF ELECTRIC SHOCK: do not carry out any type of direct operation on the internal parts of the Motoinverter, or open its cover, if it is powered. If you are in any doubt, disconnect the supply voltage from the Motoinverter (using the specific instruments on the control panel) then wait at least 60 seconds before opening the cover.
When the inverter has been disconnected from the power supply, you can open its upper cover by loosening the four screws. Any necessary maintenance operations or removal can then be carried out.

5. CONTROL

5.1 CONNECTION DIAGRAMS

No.	Connector	Notes
1	Supply connector	
2	Screw and equipotential faston connections to the earth terminal	
3	Motor connection terminals	
4	Removable 2-pole connector RS485	
5	Termination jumper RS485	
6	Connection terminal of the 4-pole watertight connector (RS485)	
7	Removable 2-pole connector with programmable digital outputs	
8	Removable 5-pole connector with digital inputs	8.C COMMON 8.1 INPUT 1 8.2 INPUT 2 8.3 INPUT 3 8.4 INPUT 4
9	3-pole connector with analogue reference	9.1 +10 V (HOT POLE) 9.2 PROPORTIONAL SPEED REFERENCE 9.3 ANALOGUE INPUT GND
10	Auxiliary digital inputs	
11	Earth connection of the input filter	
12	Connection terminal of the 4-key panel of the T version	
20	Removable 2-pole connector with digital input reaction time 2ms	INPUT 11.1 INPUT 11.2

NERIDRIVE JUNIOR – Printed Circuit Board Layout

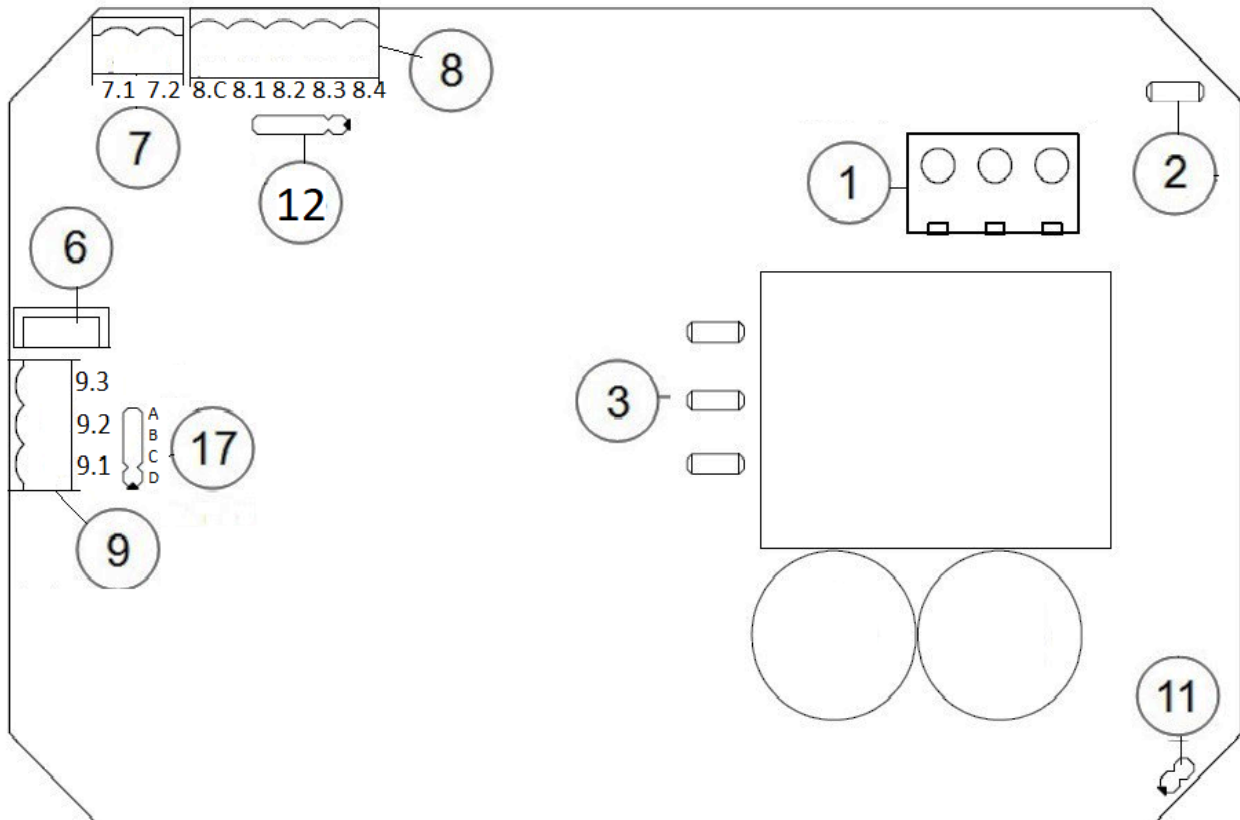

NERIDRIVE SMALL – Printed Circuit Board Layout

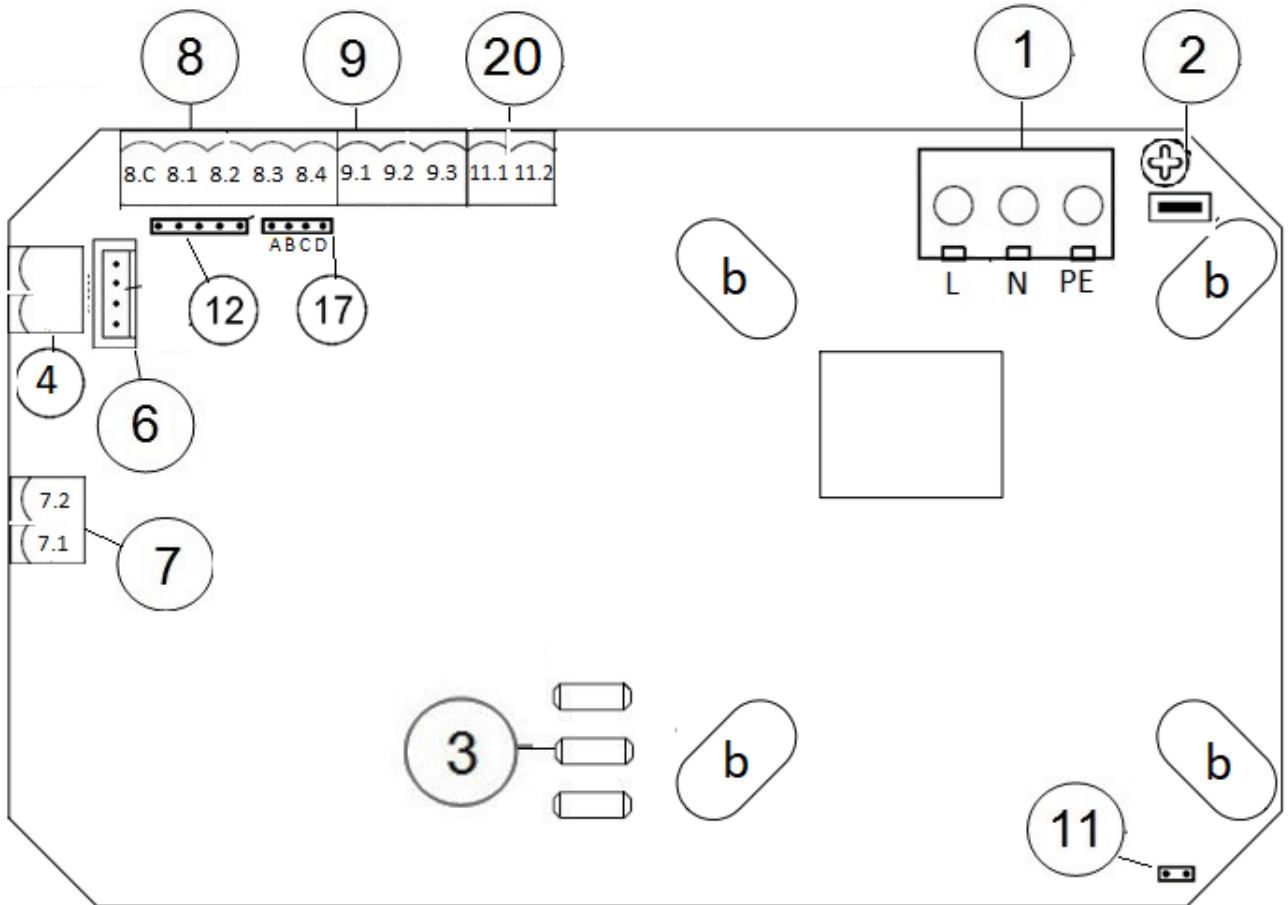

NERIDRIVE MEDIUM Single-Phase – Printed Circuit Board Layout

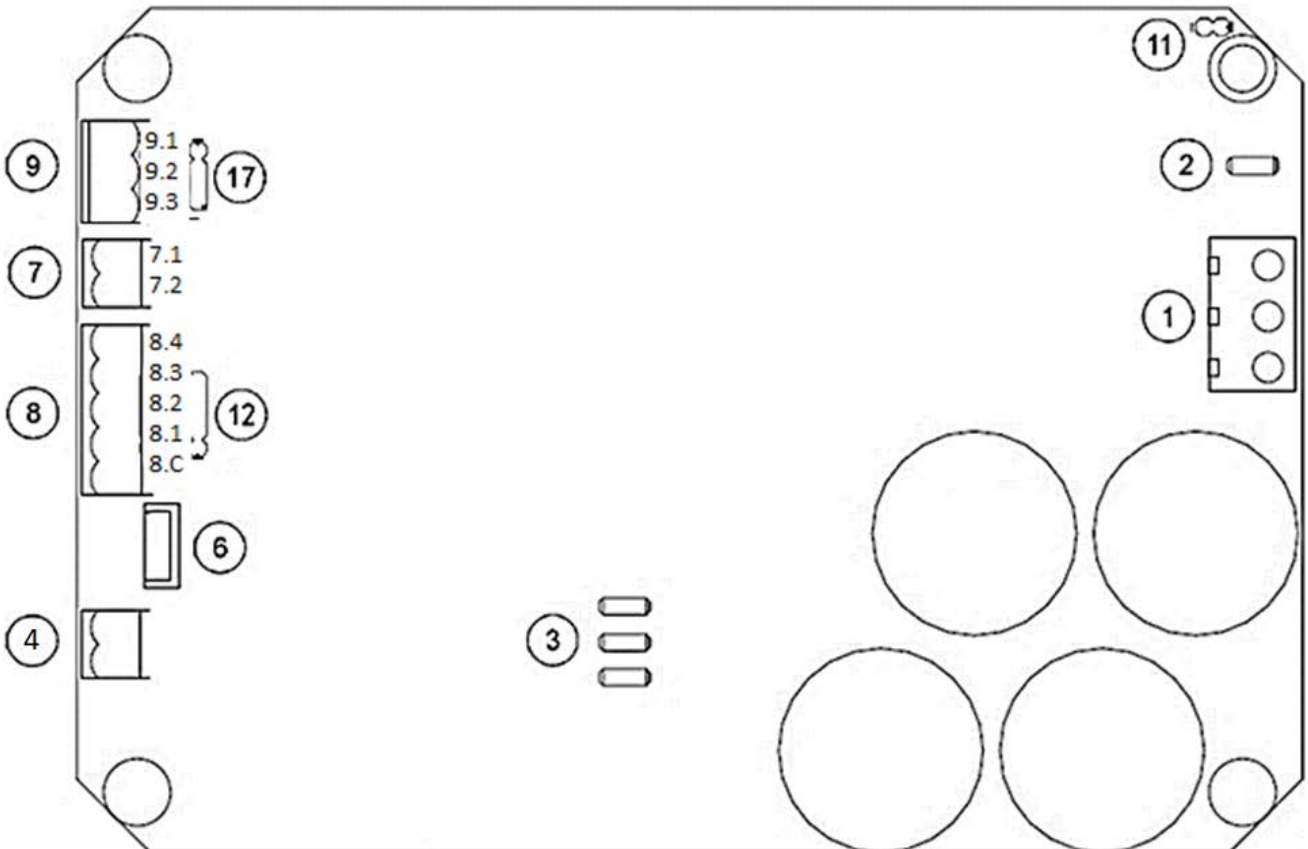

NERIDRIVE MEDIUM Three-Phase – Printed Circuit Board Layout

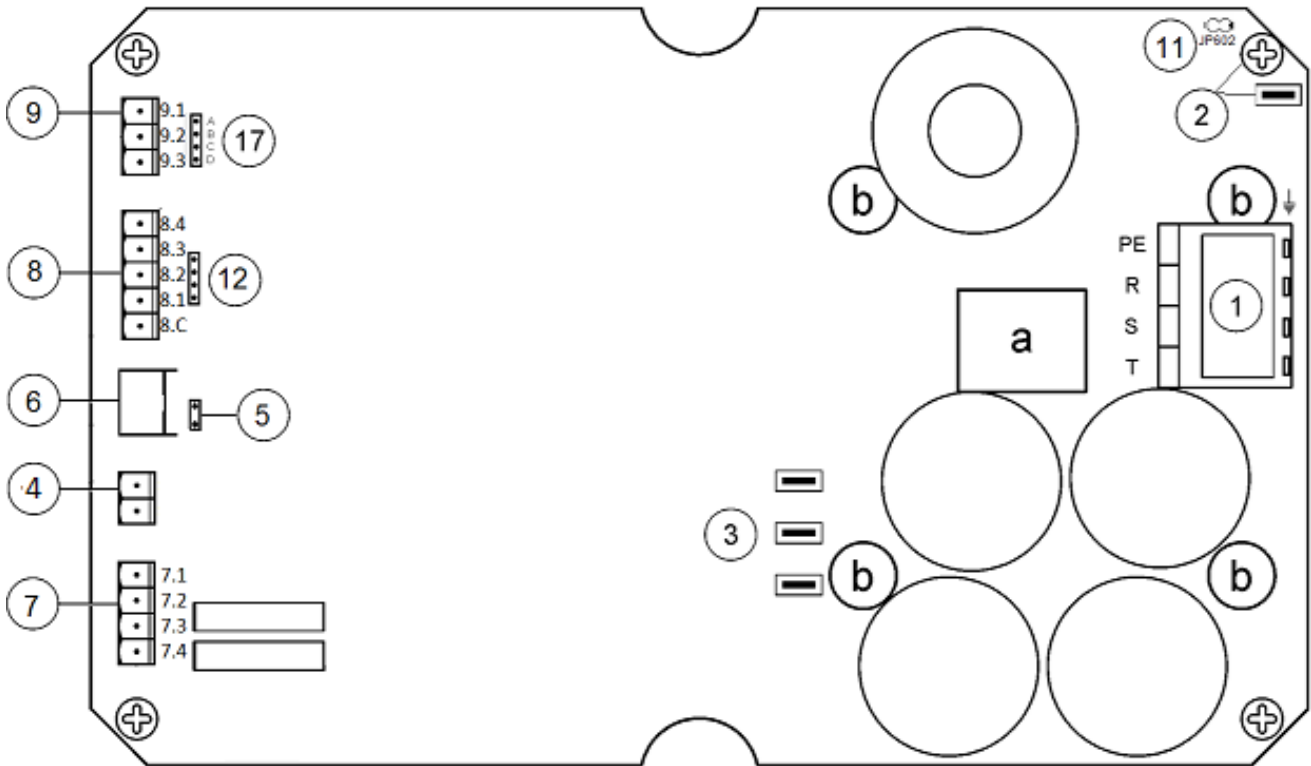

NERIDRIVE BIG Single-Phase – Printed Circuit Board Layout

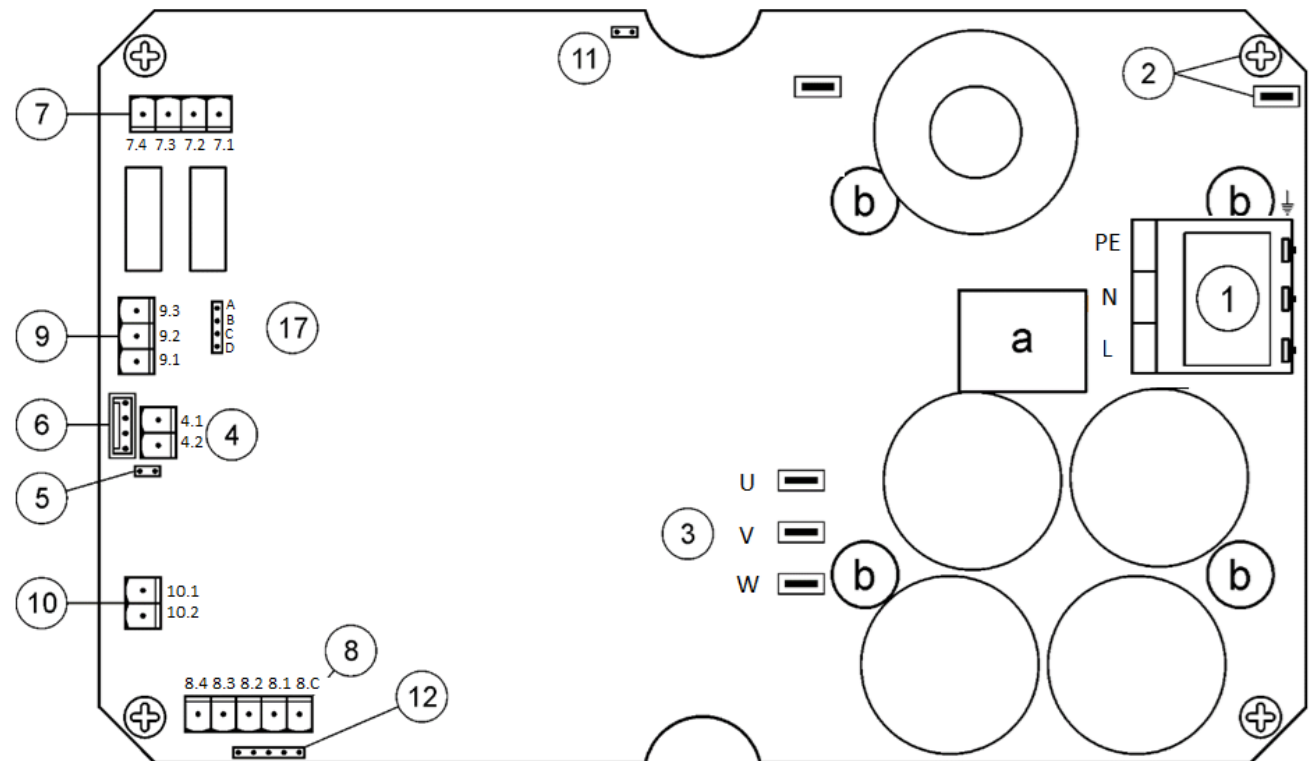

NERIDRIVE BIG Three-Phase – Printed Circuit Board Layout

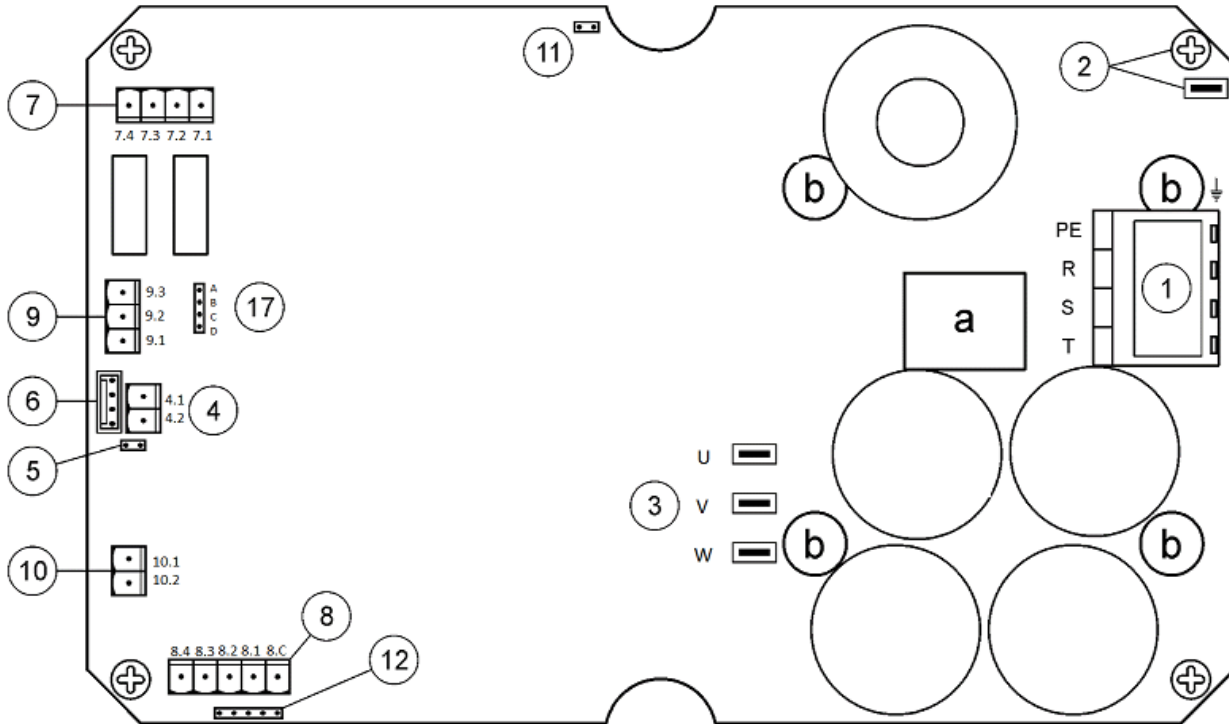

5.2 KEYPAD CONTROL

Only available for T-version (version with keypad).

Keypad	Function
	Press FWD/STOP to START the Motoinverter FORWARD Press again to STOP the Motoinverter
	Press REV/STOP to START the Motoinverter REVERSE Press again to STOP the Motoinverter
	Keep pressed ARROW UP to INCREASE SPEED
	Keep pressed ARROW DOWN to REDUCE SPEED

5.3 DIGITAL INPUTS CONTROL

The Motoinverter can be controlled by DIGITAL INPUTS 8.1/8.2/8.3/8.4. The setting of parameter s011 (default s011=04) allows different functions.

s011	Connection	Function
------	------------	----------

s011	Connection	Function
03	<p>N.C. N.C. FWD REV</p>	<p>FORWARD/STOP + REVERSE/STOP INPUT 8.2 kept closed, motor runs FORWARD INPUT 8.1 kept closed, motor runs REVERSE Both contacts open, the motor STOPS</p>
04	<p>N.C. N.C. START REV</p>	<p>START/STOP + FORWARD/REVERSE INPUT 8.2 kept closed, motor runs FORWARD INPUT 8.1 and 8.2 kept closed, motor runs REVERSE Both contacts open, the motor STOPS</p>
05	<p>Bit 2¹ Bit 2⁰ START REV</p>	<p>START/STOP + FORWARD/REVERSE + 4 SPEEDS INPUT 8.2 kept closed, motor runs FORWARD INPUT 8.1 and 8.2 kept closed, motor runs REVERSE Both contacts open, the motor STOPS INPUTS 8.3-8.4, the combination controls the SPEED</p>
08	<p>FWD REV SP+ SP-</p>	<p>POTENTIOMETER + START/STOP FORWARD + START/STOP REVERSE INPUT 8.4 kept closed, motor runs FORWARD INPUT 8.3 kept closed, motor runs REVERSE INPUT 8.2 kept closed, motor SPEED INCREASES INPUT 8.1 kept closed, motor SPEED DECREASES</p>
10	<p>REV1 REV2 FWD1 FWD2</p>	<p>2 SPEEDS FORWARD + 2 SPEEDS REVERSE INPUT 8.4 kept closed, motor runs REV SPEED 1 INPUT 8.3 kept closed, motor runs REV SPEED 2 INPUT 8.2 kept closed, motor runs FWD SPEED 1 INPUT 8.1 kept closed, motor runs FWD SPEED 2</p>
12	<p>JOG STOP START REV</p>	<p>SELF-HOLD OF THE START COMMAND See paragraph on self-hold</p>

s011	Connection	Function
14		<p>4 SPEEDS</p> <p>INPUT 8.1 kept closed, motor runs SPEED 1</p> <p>INPUT 8.2 kept closed, motor runs SPEED 2</p> <p>INPUT 8.3 kept closed, motor runs SPEED 3</p> <p>INPUT 8.4 kept closed, motor runs SPEED 4</p>

5.4 ANALOGUE INPUT CONTROL

The speed of the Motoinverter can be controlled by means of ANALOGUE INPUT 9.1/9.2/9.3.

Connection	Signal	Jumpers
	Potentiometer, 10 kOhm	<p>A=OFF B=OFF</p> <p>C=OFF D=OFF</p>
	Energised analogue signal 0 - 10V	<p>A=OFF B=OFF</p> <p>C=OFF D=OFF</p>
	Energised analogue signal 0 - 5V	<p>A=OFF B=OFF</p> <p>C-D = JUMPER</p>
	Current analogue signal 0-20 mA / 4-20 mA see parameter a001	<p>A-B = JUMPER</p> <p>C-D = JUMPER</p>

5.5 MODBUS CONTROL

For the direct connection to the terminals on the inverter tab, refer to the printed circuit board layout.

Female Connector	Functions
	1 (4.1) = RA +
	2 (reserved) = reserved for the ALS1 terminal
	3 (4.2) = RB -
	4 (reserved) = reserved for the ALS1 terminal

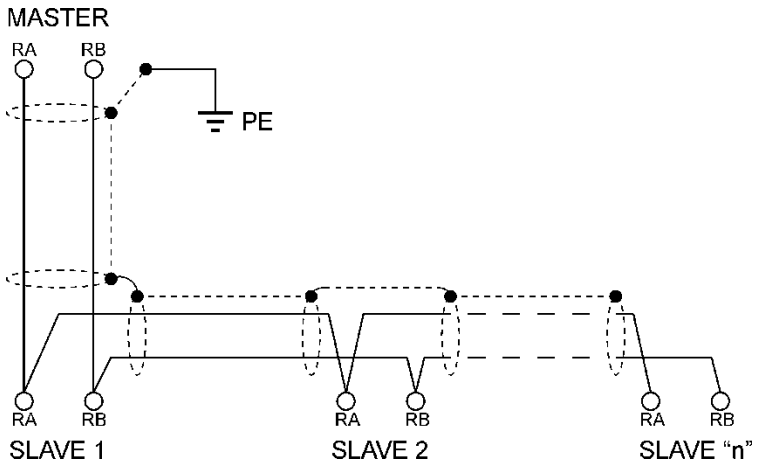
Typical connection diagram	Notes
	<p>The "MASTER" is the supervisor device, while the Motoinverter(s) is/are the "SLAVE(S)".</p> <p>Use a 2-pole, braided and shielded cable compliant with Standard IEEE RS485.</p> <p>Do not interrupt the electrical continuity of the shield.</p> <p>Reduce the parts of the unshielded cable as far as possible.</p> <p>Connect the shield to an effective earth point only on the "MASTER" side.</p> <p>Make a multi-point network by linking together all the RA terminals and then all the RB terminals, respecting the typical layout (avoid backbones as the starting point for Slave connections, and avoid star connections).</p>

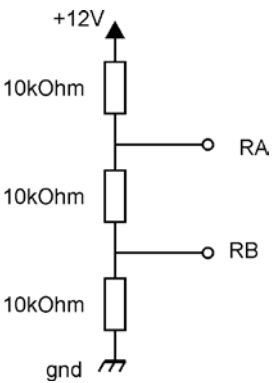
Typical master output diagram (polarisation line)	Notes
	<p>Ensure the Master can polarise the line with a compatible output layout (as far as possible) with the one shown here. If you have any doubts, don't hesitate to contact our Technical Service for further information.</p> <p>If the Master doesn't have an output circuit that can polarise the line, transmission via the serial line can still work but performance levels may be reduced.</p>

5.6 DIGITAL PROGRAMMING TERMINAL ALS1

To program the inverter, you need to connect the Digital Programming Terminal accessory through the ALS1 Adaptor Cable for Programming Terminal.

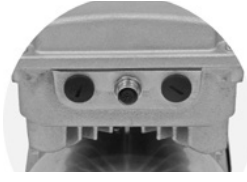
 <p data-bbox="156 1594 702 1630">ALS1 adaptor cable for programming terminal</p>	<p>Connect the ALS1 adaptor cable for programming terminal to the connection terminal of the RS485 4-pole watertight connector (see no. 6 of the card's layout).</p>
	<p>Loosen and remove the connector protection cap. Screw the ALS1 adaptor cable for programming terminal to the inverter box.</p> <p>Insert the mobile connector of the terminal, making sure the phase tooth inside the connector is aligned. Tighten the mobile connector.</p>



Connect the programming terminal through the 4-pole female connector.
 The terminal can be connected and removed even while the inverter is powered.
 As soon as it is connected, the terminal shows the software revision code for 2 seconds then goes to the "d" display mode set via the parameters (see parameter s010).

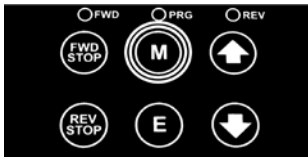

Press M to slide the group of parameters



Use the ARROWS to change the parameter

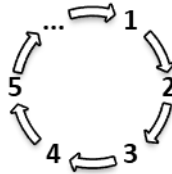

Press E to select the parameter



Use the ARROWS to change the value of the parameter



Press E to memorize the parameter
 Press M to exit from the parameter

5.7 REMOTE CONTROL TERMINAL ALS3

Connection diagram of remote control terminal ALS3:

Digital Input	Cable colors
8.C	Grey
8.1	Pink
8.2	Yellow
9.1	Brown
9.2	White
9.3	Green

5.8 PROGRAMMABLE DIGITAL OUTPUTS

The Motoinverter is equipped as standard with two relay outputs with a n.o. contact (max. 110V AC/DC – 4 A resistive). Their functions can be independently programmed and timed via the "O" parameters.

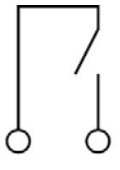
Connection	Programmable functions	Programmable timings
OUTPUT  7.1 7.2	See parameters O001 and O002	See parameters O101 , O102 , O103 , O104

5.9 SPECIAL OPERATING MODES

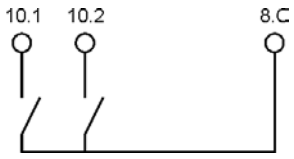
Connection	Functions
	Special functions



For the map of the Modbus registers, and for protocol details, please request the "Modbus manual for NERIDRIVE"

6. PARAMETERS

6.1 LIST OF PARAMETERS

Parameter	Description	Variation field	Default value	Unit of measure
a001	Analogue configuration 1	0 - 2	0	-
a002	Analogue configuration 2	0 - 2	0	-
d001	Output frequency	-	-	Hz
d002	Motor speed	-	-	rpm
d003	Set frequency	-	-	Hz
d004	Voltage to the motor	-	-	V
d005	Current to the motor	-	-	A
d006	Power supplied to the motor	-	-	W
d007	Motor $\cos\phi$	-	-	-
d008	DC bus voltage	-	-	V
d009	Inverter temperature	-	-	°C
d010	Slide	-	-	Hz
d011	Status of inputs IN1-IN2-IN3-IN4	-	-	0000
d012	Status of outputs OT1-OT2	-	-	00
d013	Level of analogue input 1	-	-	%
d014	Level of analogue input 2	-	-	%
d100	Number of stored errors	-	-	-
d101	Last error	-	-	-
d102	Penultimate error	-	-	-
d103	Third last error	-	-	-
d104	Fourth last error	-	-	-
d105	Fifth last error	-	-	-

Parameter	Description	Variation field	Default value	Unit of measure
d201	Inverter firmware version	-	-	-
d201	ALS1 terminal firmware version	-	-	-
f001	Maximum frequency SPEED1	0 - S001	50	Hz
f002	Minimum frequency SPEED1	0 - F001	3	Hz
f003	Maximum frequency SPEED2	0 - S001	50	Hz
f004	Minimum frequency SPEED2	0 - F003	3	Hz
f005	Maximum frequency SPEED3	0 - S001	50	Hz
f006	Minimum frequency SPEED3	0 - F005	3	Hz
f007	Maximum frequency SPEED4	0 - S001	50	Hz
f008	Minimum frequency SPEED4	0 - F007	3	Hz
f009	Acceleration ramp SPEED1	0.05 - 99.9	5.00	s
f010	Deceleration ramp SPEED1	0.05 - 99.9	5.00	s
f011	Acceleration ramp SPEED2	0.05 - 99.9	5.00	s
f012	Deceleration ramp SPEED2	0.05 - 99.9	5.00	s
f013	Acceleration ramp SPEED3	0.05 - 99.9	5.00	s
f014	Deceleration ramp SPEED3	0.05 - 99.9	5.00	s
f015	Acceleration ramp SPEED4	0.05 - 99.9	5.00	s
f016	Deceleration ramp SPEED4	0.05 - 99.9	5.00	s
f017	Analogue reference SPEED1	0 - 7	3	-
f018	Analogue reference SPEED2	0 - 7	3	-
f019	Analogue reference SPEED3	0 - 7	3	-
f020	Analogue reference SPEED4	0 - 7	3	-
i001	Status of input 1 (8.1)	0 - 1	0	-
i002	Status of input 2 (8.2)	0 - 1	0	-
i003	Status of input 3 (8.3)	0 - 1	0	-
i004	Status of input 4 (8.4)	0 - 1	0	-
i005	Status of input 5 (10.1)	0 - 1	0	-
i006	Status of input 6 (10.2)	0 - 1	0	-
O001	Function of output 1	0 - 10	8	-
O002	Function of output 2	0 - 10	5	-
O101	Excitation delay output 1	0 - 9.99	0	-
O102	De-energisation delay output 1	0 - 9.99	0	-
O103	Excitation delay output 2	0 - 9.99	0	-
O104	De-energisation delay output 2	0 - 9.99	0	-
p001	Command configuration (not standard)	0 - 7	00	-
p002	Enabled directions	0 - 2	00	-
p003	Stop mode	0 - 1	00	-
p004	Running direction at switch-on	0 - 1	00	-
p005	Movement safety	0 - 1	00	-
p006	0 reference frequency	0 - 1	00	-
p007	Brake at 0 frequency	0 - 1	00	-
p008	Potentiometer reset	0 - 1	00	-
p009	Modulation frequency automatic reduction	0 - 1	00	-
p010	Cos ϕ protection	0.4 - 0.99	0.90	-

Parameter	Description	Variation field	Default value	Unit of measure
p011	Integration time	5 - 1800	480	s
p012	Minimum inverter frequency	0 - 159	3.00	Hz
p013	Number of restarts in the event of an error	0 - 200	Off	-
p014	Time between one restart attempt and the next	0 - 3600	1	s
p015	Modbus slave address	1 - 247	001	-
p016	Communication speed	9600	9600	-
p017	Time-out for communication on RS485	0 - 60	02	-
p018	Alarm memory reset	1	00	-
p019	Current limit	*	*	A
p020	Reserved parameter	-	-	-
p021	Reserved parameter	-	-	-
p022	Reserved parameter	-	-	-
p023	Speed control with PID	0 - 1	1	-
p099	Back to default values	0 - 1	00	-
s001	Maximum frequency	0 - 159	50	Hz
s002	Minimum frequency	0 - 159	3	Hz
s003	Acceleration ramp	0.1 - 99.9	5.00	s
s004	Deceleration ramp	0.1 - 99.9	5.00	s
s005	DC bus voltage	400 - 440	400	V
s006	Nominal speed	-	-	rpm
s007	Reduction ratio	10 - 9999	1	-
s008	Number of motor poles	2 - 4 - 6 - 8	-	-
s009	Switchover frequency	2.5 - 15	7.5	kHz
s010	"d" parameter displayed at switch-on	1 - 14	1	-
s011	Speed reference configuration	1 - 20	4	-

6.2 GROUP OF "S" PARAMETERS

s001 - MAXIMUM FREQUENCY - This is the frequency reached with the speed reference at maximum (5 V or 10 V in the case of a voltage reference, 20 mA in the case of a current reference). All the models have a factory setting of 50 Hz. There is no limit to the increase of this value (up to 159 Hz), so it is necessary to pay attention when evaluating the maximum speed that the drive and mechanics connected to the motor can actually tolerate (e.g.: 159 Hz on a 2-pole motor corresponds to over 9000 rpm).

s002 - MINIMUM FREQUENCY - This is the frequency reached with the speed reference at 0V. It has a factory setting of 3 Hz, but this value can be reduced. There is no limit to the increase of this value, until a value of 0.1 Hz is reached lower than the maximum frequency set in **s001**. With the reference at 0V, the motor can be stopped regardless of the value set for this parameter, by setting parameter **p006** at **01**.

s003 - ACCELERATION RAMP - This is the time taken to accelerate from 0 to 50 Hz. The motor's total acceleration time will depend on the speed jump made (e.g. if the set maximum frequency is 100 Hz, a value of "5" in this parameter will produce an acceleration time of 10 seconds in the phase from 0 to 100 Hz). Attention: excessively short ramps can cause the protection device to trip due to overcurrent in acceleration and overvoltage in deceleration. Below 1.00s, it varies in steps of 0.05s.

s004 - DECELERATION RAMP - This is the time taken to decelerate from 50 Hz to 0 Hz. The motor's total deceleration time will depend on the speed jump made (e.g. if the set maximum frequency is 100 Hz, a value of "5" in this parameter will produce a deceleration time of 10 seconds in the phase from 100 Hz to 0 Hz). Below 1.00s, it varies in steps of 0.05s.

s005 - DC BUS VOLTAGE - This parameter should usually be kept at the factory setting, although it can be modified for particular applications.

s006 - NOMINAL MOTOR SPEED - This parameter cannot be modified. It depends on the value set in **s008**.

s007 - REDUCTION RATIO - Used to set the mechanical ratio between the motor shaft and the load. Starting from parameter **s006**, it allows you to view the motor output speed in parameter **d002**. A value of 1 is neutral (no ratio between the motor and the output); values from -10 to -1 are multiplication ratios; values from 2 to 9999 are reduction ratios. A value of 0 is permitted, but has no meaning.

s008 - NUMBER OF MOTOR POLES - This parameter is used to set the number of poles of the motor combined with the inverter in order to obtain the correct speed display (in the "d" group parameters).

s009 - SWITCHOVER FREQUENCY - This is the switchover frequency of the IGBTs. High values allow Motoinverter to operate without audible frequencies being generated. The Motoinverter can be enabled (parameter **p009**) to autonomously reduce the switchover frequency up to 7.5 kHz during operation in the event of a prolonged overload.

s010 - "d" PARAMETER DISPLAYED AT SWITCH-ON - At switch-on, the programming terminal goes directly to the visualisation indicated in this parameter. Refer to the list of "d" parameters for the possible visualisations.

s011 - SPEED REFERENCE CONFIGURATION - Selects the main speed reference. Also sets a standard configuration for the digital command inputs (which can be modified if the value of parameter **p001** is set with a value other than 0).

s011	Main reference	Standard configuration of the digital inputs
01	Reserved mode	Reserved for special versions
02	Reserved mode	Reserved for special versions
03	Analogue 2	FORWARD/STOP + REVERSE/STOP INPUT 8.2 kept closed, motor runs FORWARD INPUT 8.1 kept closed, motor runs REVERSE Both contacts open, the motor STOPS
04	Analogue 1	START/STOP + FORWARD/REVERSE INPUT 8.2 kept closed, motor runs FORWARD INPUT 8.1 and 8.2 kept closed, motor runs REVERSE Both contacts open, the motor STOPS
05	4 Speeds	START/STOP + FORWARD/REVERSE + 4 SPEEDS INPUT 8.2 kept closed, motor runs FORWARD INPUT 8.1 and 8.2 kept closed, motor runs REVERSE Both contacts open, the motor STOPS INPUTS 8.3-8.4, the combination controls the SPEED See parameter "F"
06	Keypad	NO INPUT AVAILABLE 4 keys of the keypad allow the FORWARD/REVERSE and the speed setting
07	ALS1 terminal	NO INPUT AVAILABLE ALS1 terminal, ALS2 terminal, Modbus RTU
08	Potentiometer on the outside of the motor	POTENTIOMETER + START/STOP FORWARD + START/STOP REVERSE INPUT 8.4 kept closed, motor runs FORWARD INPUT 8.3 kept closed, motor runs REVERSE INPUT 8.2 kept closed, motor SPEED INCREASE INPUT 8.1 kept closed, motor SPEED DECREASE
09	Remote control	Reserved for special versions
10	2 + 2 SPEEDS	2 SPEEDS FORWARD + 2 SPEEDS REVERSE INPUT 8.4 kept closed, motor runs REVERSE SPEED 1

s011	Main reference	Standard configuration of the digital inputs
		INPUT 8.3 kept closed, motor runs REVERSE SPEED 2 INPUT 8.2 kept closed, motor runs FORWARD SPEED 1 INPUT 8.1 kept closed, motor runs FORWARD SPEED 2
11	Reciprocator	See par 8.4
12	Self-hold	See par 8.5

6.3 GROUP OF “P” PARAMETERS

Parameter	Description	Values	Meaning	Default value
p001	Command configuration (not standard)	0	Takes its configuration from parameter s011	00
		1	Not available	
		2	IN2 = FWD/REV - IN1 = START/STOP (with analogue 2)	
		3	IN2 = FWD/STOP - IN1 = REV/STOP	
		4	IN2 = FWD/REV - IN1 = START/STOP - IN4=EXT. FAULT	
		5	Cannot be used in multispeed mode	
		6	Keypad	
		7	Modbus	
p002	Enabled directions	0	Both running directions are enabled	00
		1	Only FORWARD running enabled	
		2	Only REVERSE running enabled	
p003	Stop mode	0	Stop with ramp	00
		1	Stop due to inertia	
p004	Running direction at switch-on	0	FORWARD	00
		1	REVERSE	
p005	Movement safety	0	Automatic restart at SWITCH-ON	00
		1	Restart not permitted	
p006	0 reference frequency	0	Motor at minimum with reference = 0 V	00
		1	Motor stopped with reference = 0 V	
p007	Brake at 0 frequency	0	Motor shaft free below minimum frequency	00
		1	Motor braked below minimum frequency	
p008	Potentiometer reset	0	Stores the last speed	00
		1	Restarts from 0 at every switch-on	
p009	Modulation frequency automatic reduction	0	Disabled	00
		1	Enables automatic reduction of PWM modulation in the event of overtemperature	
p010	Cos ϕ protection	from 0.4 to 0.99	Protection value for cos ϕ	0.90
p011	Integration time	from 5 to 1800	Time before cos ϕ protection trigger	480
p012	Minimum inverter frequency	0 - 159	Frequency at which the inverter begins to generate the supply sinusoids for the motor	3.00
p013	Number of restarts in the event of an error	0	Disables auto restart	0
		1 - 200	No. of restart attempts	

Parameter	Description	Values	Meaning	Default value
p014	Time between one restart attempt and the next	0 - 3600	Standby value in seconds between one automatic restart attempt and the next	1
p015	Modbus slave address	1 - 247	Slave address in the RS485 message	001
p016	Communication speed	9600	Baud rate in the communication via RS485	9600
p017	Time-out due to communication on RS485	0	Time-out excluded	2
		1 - 59	Time-out value in seconds for communication on RS485 (MODBUS and ALS1 terminal)	
p018	Reset alarm memory	1	Resets the alarm memory	00
p019	Current limit	*	Peak current limit depends on the size of the Motoinverter	*
p020	Reserved parameter	-	-	-
p021	Reserved parameter	-	-	-
p022	Reserved parameter	-	-	-
p023	Speed control with PID	0	0 = PID disabled	1
		1	1 = PID enabled	
p099	Restores default values	1	Restores all the default parameters	00

p001 - CONFIGURATION OF RUN AND REVERSE COMMAND - If the value is other than "0", select an operating mode in which the speed reference is the one set in parameter **s011** and the START/REVERSE commands are those selected by this parameter.

p004 ROTATION DIRECTION ON SWITCH - Used to reverse the motor's running direction (the same result is obtained by not altering the programming and by inverting the two motor phases).

p005 - MOVEMENT SAFETY - This operating mode can be obtained with all the reference configurations set via parameter **s011**. It is an especially important mode in all applications where any possible voltage failure (e.g. a blackout) and the subsequent power supply reset could be risky for people or objects when the mechanical parts of the system/machine restart. If parameter **p005** has a value of 1, when the power supply is restored the START command (which may have remained enabled) returns to "disabled" status and is then re-enabled so that the motor can restart. If parameter **p005** has a value of 0 (the default value), when the power supply is restored the motor (which was running when the voltage failure occurred) automatically begins running once again. This operating mode is usually required for various types of application (cooling pumps, ventilation systems, etc.).

	<p>It's very important to note that this mode is handy for ensuring a high level of safety, but it has no redundancy control and is not available in Motoinverters with "intrinsic safety" components. Setting parameter p005 to "restart not permitted" does not therefore mean the Motoinverter installer can ignore the need to adopt the most suitable solutions (outside the Motoinverter) for ensuring user safety, as indicated in the "Machinery Directive" and the standardised regulations applicable for this product.</p>
---	--

p006 - ZERO REFERENCE FREQUENCY - This parameter indicates whether the motor must run at the minimum frequency (set in parameter **s002**) or remain idle when the analogue speed reference is zero.

p007 - BRAKE AT ZERO FREQUENCY - Indicates whether the motor shaft must be free or in torque below the minimum frequency (set in parameter **s002**). At zero speed, the torque value is about 1/5 of the nominal torque. Pay great attention when using the operating mode with the motor in torque when the shaft is idle, as the motor may overheat; for this reason, it is advisable not to use it if the motor is not equipped with at least an auxiliary servo ventilation device.

p008 - POTENTIOMETER RESET - In configurations where a potentiometer is envisaged (**s011**= **06** or **08**), this allows you to store the last speed set or to restart from the minimum speed at the first start-up after every new energisation of the Motoinverter. Attention: the motor speed changes straight away but is stored by the inverter roughly every 5 seconds, so a de-energisation immediately after a speed change may not allow a restart at the last speed set.

p010-p011- Cosφ PROTECTION - INTEGRATION TIME - During operation, the inverter measures the motor power factor (which, when it rises above certain limits, indicates that the motor is overheating). The value set in **p010** determines the threshold, while the value of **p011** represents the integration time (in seconds) for the average of 5 values. When the average value exceeds the threshold value, the protection is triggered and "err pf" is displayed.

p012- MINIMUM INVERTER FREQUENCY - This parameter establishes the minimum frequency at which the inverter begins to generate a voltage; the "MINIMUM FREQUENCY" value set in parameter **s002** determines the minimum speed at which the motor can be taken from the speed reference, but if this value is also set at 10 Hz for example, the supply to the motor at "START" will be generated starting from the "minimum inverter frequency".

p013-p014 - NUMBER OF RESTART attempts in the event of an error - time between one restart attempt and the next - Allows the inverter to attempt an automatic restart in the event of an error (due to the triggering of an internal protection device). You can establish the number of attempts, and the standby time between one attempt and the next. This function should be used with due caution, but it's very handy, for example, if the system is not monitored or to check hydraulic pumps or ventilation systems where the manual resetting of the protection device may not be easy or quick enough for continuous system operation. If parameter **p013** is set at "0" (factory setting), the automatic restart function is disabled. If the error is due to reversible malfunctioning (e.g. overtemperature), only a de-energisation or a new start signal can restart the motor.

	When programming the automatic reset function, bear in mind the safe use of the system and take all the necessary measures (besides the inverter) to prevent an automatic motor restart if there may be any hazardous situation for maintenance workers.
---	--

p018 - ALARM MEMORY RESET - The inverter is equipped with a function for storing the number and type of alarms that occur (only the last 5). These alarms can be viewed in parameters **d100-d105**. Using the ALS1 terminal to set a value of 1 for parameter **p018** and then pressing ENTER, the alarm memory is reset.

p019 - CURRENT LIMIT - In this parameter you can set the current threshold beyond which the inverter enters protection mode due to motor overload.

	Attention: in any case, refer to the rated current indicated on the rating plate and do not exceed a value double that indicated by the motor manufacturer!
---	---

p020 / p021/ p022 - RESERVED PARAMETERS - Present on certain inverter versions.

p099 - RESTORE DEFAULT – You can restore the inverter to the original factory configuration with this parameter.

6.4 GROUP OF “F” PARAMETERS

These are used to set the rotation frequencies in the various operating modes.

Parameter	Description	Range	Default value	Unit of measure	Meaning
f001	Maximum frequency SPEED1	0 - s001	50	Hz	Rotation frequency with IN3=OFF and IN4=OFF
f002	Minimum frequency SPEED1	0 - s001	3	Hz	Minimum frequency if Analogue ref. F017 is assigned
f003	Maximum frequency SPEED2	0 - s001	50	Hz	Rotation frequency with IN3=ON and IN4=OFF
f004	Minimum frequency SPEED2	0 - s003	3	Hz	Minimum frequency if Analogue ref. F018 is assigned
f005	Maximum frequency SPEED3	0 - s001	50	Hz	Rotation frequency with IN3=OFF and IN4=ON
f006	Minimum frequency SPEED3	0 - f005	3	Hz	Minimum frequency if Analogue ref. F019 is assigned
f007	Maximum frequency SPEED4	0 - s001	50	Hz	Rotation frequency with IN3=ON and IN4=ON
f008	Minimum frequency SPEED4	0 - f007	3	Hz	Minimum frequency if Analogue ref. F020 is assigned
f009	Acceleration ramp SPEED1	0.05 - 99.9	5.00	s	Transit ramp to F001, ramp referred to 50 Hz
f010	Deceleration ramp SPEED1	0.05 - 99.9	5.00	s	Transit ramp to F002, ramp referred to 50 Hz
f011	Acceleration ramp SPEED2	0.05 - 99.9	5.00	s	Transit ramp to F003, ramp referred to 50 Hz
f012	Deceleration ramp SPEED2	0.05 - 99.9	5.00	s	Transit ramp to F004, ramp referred to 50 Hz
f013	Acceleration ramp SPEED3	0.05 - 99.9	5.00	s	Transit ramp to F005, ramp referred to 50 Hz
f014	Deceleration ramp SPEED3	0.05 - 99.9	5.00	s	Transit ramp to F006, ramp referred to 50 Hz
f015	Acceleration ramp SPEED4	0.05 - 99.9	5.00	s	Transit ramp to F007, ramp referred to 50 Hz
f016	Deceleration ramp SPEED4	0.05 - 99.9	5.00	s	Transit ramp to F008, ramp referred to 50 Hz
f017	Analogue reference SPEED1	0 - 7	3	-	Assigns the speed reference source to SPEED1
f018	Analogue reference SPEED2	0 - 7	3	-	Assigns the speed reference source to SPEED2
f019	Analogue reference SPEED3	0 - 7	3	-	Assigns the speed reference source to SPEED3
f020	Analogue reference SPEED4	0 - 7	3	-	Assigns the speed reference source to SPEED4

6.5 GROUP OF “A” PARAMETERS

Parameter	Description	Value set	Meaning	Default value
a001	Analogue	0	0-10 V	0

Parameter	Description	Value set	Meaning	Default value
a002	configuration 1	1	0-20 mA	0
		2	4-20 mA	
	Analogue configuration 2	0	0-10 V	
		1	0-20 mA	
		2	4-20 mA	

6.6 GROUP OF "I" PARAMETERS

Parameters from i001 to i006 are used to choose whether each input is ACTIVATED by a N.O. contact that works if closed, or a N.C. contact that works if opened.

Numerical value 00 or 01 can be assigned to each input, adapting the inverter to a wide range of control layouts (also pre-existing).

Parameter	Description	Value set	Meaning	Default value
i001	Input activation status 1 (8.1)	00	The input is activated by the closure of the contact (use n.o. contact)	0
		01	The input is activated by the opening of the contact (use n.c. contact)	0
i002	Input activation status 2 (8.2)	As above	As above	0
i003	Input activation status 3 (8.3)	As above	As above	0
i004	Input activation status 4 (8.5)	As above	As above	0
i005	Input activation status 5 (10.1)	As above	As above	0
i006	Input activation status 6 (10.2)	As above	As above	0

6.7 GROUP OF "O" PARAMETERS

These parameters are used for the software configuration of the output functions on the relay (option only available upon request).

Parameter	Description	Value set	Meaning	Default value
O001	Function of output 1	0	Output not enabled	8
		1	READY (power supply OK, no alarm)	
		2	RUN (operations in progress)	
		3	STOP (stop in progress)	
		4	REVERSE (backward running)	
		5	Deceleration ramp in progress	
		6	Acceleration ramp in progress	
		7	End of acceleration ramp	
		8	Alarm in progress	
		9	No error in progress	
		10	Under remote control via RS485	
O002	Function of output 2	0 - 10	As for output 1	5
O101	Excitation delay output 1	0 - 10	Delay time between the function and the	0

Parameter	Description	Value set	Meaning	Default value
			excitation of output 1	
O102	De-energisation delay output 1	0 - 9.99	Delay time between the function and the de-energisation of output 1	0
O103	Excitation delay output 2	0 - 9.99	Delay time between the function and the excitation of output 2	0
O104	De-energisation delay output 2	0 - 9.99	Delay time between the function and the de-energisation of output 2	0

6.8 GROUP OF “d” PARAMETERS

These are display parameters for checking the main adjustment variables (via the ALS1 terminal). The parameter shown by default at switch-on is the one set in **s010**.

7. APPLICATION EXAMPLES

7.1 "4 SPEEDS" MODE

Set s011 = 05

In this mode, the combination of inputs IN3 and IN4 allows you to select up to 4 different speeds (as shown in the "F" parameters). Speeds can be fixed, in which case the pairs of parameters (f001-f002; f003-f004; f005-f006 and f007-f008) must be set at the same value, i.e. at the frequency required for that speed selection. Alternatively, you can obtain speeds that comply with the analogue reference as well (within the limits set by parameters f017...f020); in this case, the foregoing pairs of parameter define the maximum and minimum frequency limits, respectively, for each speed selection. The frequency limits that can be set are in any case determined by parameters s001 and s002. The acceleration and deceleration ramps for each speed can also be individually set with parameters f009 - f016.

Example of a speed profile and input status

Suppose we want to run the motor with the following four speed pre-selections:

Speed 1 = between 10 and 50 Hz

Speed 2 = 100 Hz

Speed 3 = 40 Hz

Speed 4 = 5 Hz

The parameters to be set, starting from the default parameters (called up if necessary by setting p099=1), are the following:

s001 = 100	f004 = 100
s011 = 5	f005 = 40
f001 = 50	f006 = 40
f002 = 10	f007 = 5
f003 = 100	f008 = 5

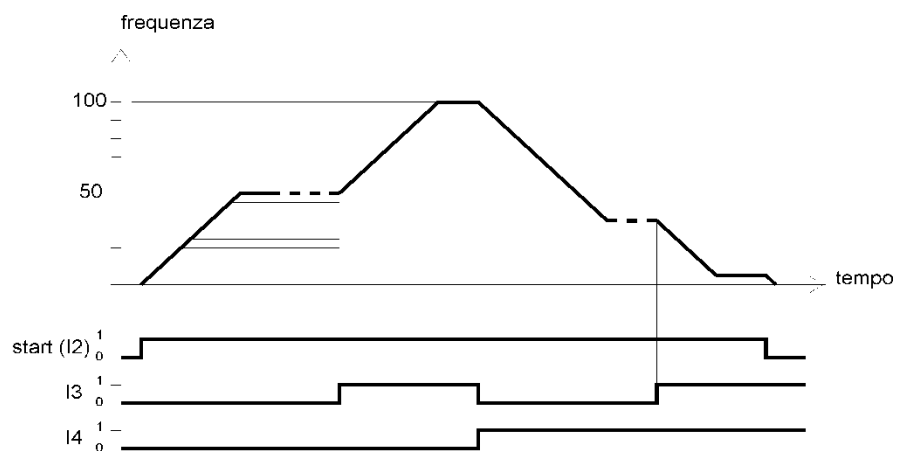

All the speeds have an opposite equivalent in relation to the horizontal axis (negative frequency); this can be obtained by activating INPUT 1 ("REV" function).

7.2 "2 + 2 SPEEDS" MODE

Set s011 = 08

In this mode, inputs IN1 and IN2 can be combined with two speeds in one running direction, and inputs IN3 and IN4 can be combined with two speeds in the opposite direction. Also, in this case, the speeds can be fixed (by setting the same value for each "maximum frequency-minimum frequency" pair) or may vary based on the reference source set in parameters f017 - f020.

Active input	Selected speed	f max set via parameter	f min set via parameter
IN 1 (8.1)	1st FORWARD	F1	F2
IN 2 (8.2)	2nd FORWARD	F3	F4
IN 3 (8.3)	1st BACKWARD	F5	F6
IN 4 (8.4)	2nd BACKWARD	F7	F8

7.3 "8 SPEEDS" MODE

Set **s011 = 14**

In this mode, each input is associated with a frequency that the motor will reach once the relevant input has been activated. However, if several inputs are activated simultaneously, the associated frequencies are added together until the maximum frequency set in parameter **s001** is reached.

Active input	Selected speed	FMax set via parameter	FMin set via parameter
IN 1 (8.1)	Frequency 1	F1	F2
IN 2 (8.2)	Frequency 2	F3	F4
IN 3 (8.3)	Frequency 3	F5	F6
IN 4 (8.4)	Frequency 4	F7	F8

7.4 RECIPROCATOR MODE

Set **s011 = 11**

Typical application: a linear axis that moves backwards and forwards between two end stop sensors, with a "START" command and a "STOP IN PHASE" function.

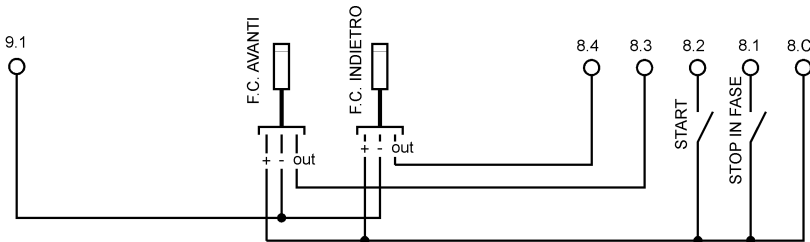

The diagram above shows a typical command input connection.

The end stop sensors are of the PNP normally open type. They must be appropriately activated by a cam when the axis reaches its maximum stroke point. The inverter feeds the sensors (15 V DC voltage between 8.C and 9.1, with positive on 8.C).

The motor speed is adjusted by analogue input 1 (potentiometer or reference on terminal block 9).

By activating the "START" input, the motor will start up in the "FWD" direction. Running will continue until input 8.3 is activated. On the front of that input, the running direction will be changed to "REV" (with deceleration and acceleration ramps programmed via parameters **s003** and **s004**). When input 8.4 is activated, its front will bring the running direction back to "FWD". And so on. The motor can be stopped at any time by deactivating the "START" input (obtaining a deceleration due to inertia or the ramp, as per parameter **p003**).

By activating the "STOP IN PHASE" input, the motor will stop with the next activation of either input IN3 (terminal 8.3) or input IN4 (terminal 8.4). In this situation, you can deactivate the "START" input and end the positioning cycle or deactivate the "STOP IN PHASE" input again to restart in the opposite direction. The activation of the START input while one of the two ends stop inputs is already active causes the motor to run in the "opposite" direction.

The delay at the sensor signal acquisition is usually about 150 ms.

If the reverse signal comes from two potential-free contacts (buttons or relays rather than PNP sensors), just connect the two ends stop contacts like the START command contact.

7.5 SELF-HOLD MODE

Set s011 = 12

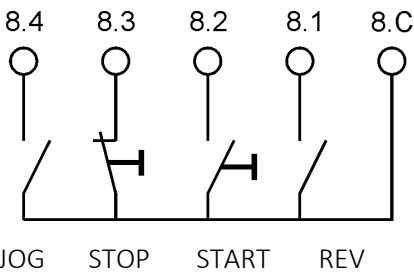

Operating principle:

The REV input must be maintained in order to reverse the motor direction.

The START input is acquired on the impulse front (100 mS filtering). The inverter only starts up if the STOP input is active. It is therefore an impulse with a self-hold circuit inside the inverter.

JOG STOP START REV

When the STOP contacts opens (on the opening front, filtered at 100 mS), the motor stops on the ramp.

If "JOG" is closed:

and the inverter is operating, there is a stop on the ramp;

and the inverter is idle, the START activation does not cause the self-hold of the movement command ("JOG" mode, in which the motor only runs if the START key is held down).

Attention: in any case, if STOP is open, it prevails over any possible START command, so the motor will not start up (either in SELF-HOLD or JOG).

8. DIAGNOSTICS AND TROUBLESHOOTING

8.1 VIEWING ERRORS AND PROTECTION DEVICES

By connecting the ALS1 terminal to the Motoinverter in lockout, you can check the error code and, thanks to the information in the paragraph below, identify the type of protection device that has been triggered.

If the Motoinverter has already been cut off from the power supply, you can still access the memory of the last five errors once the ALS1 terminal is connected.

If the "auto restart" function is enabled after an error (parameter p013 not at 00), every intervention of a protection device is stored.

In parameter p014 you can programme the gap (in seconds) between the triggering of the protection device and the subsequent restart attempt.

If the "auto restart" function is disabled (parameter p013 = 00), the motor can be restarted (after removing the cause of the protection intervention) with a new START command from the appropriate command input.

Error codes (stored in parameters d101-d105)

Code	Display	Description
01	err ot	Overtemperature
02	err ol	Overcurrent
03	err ef	External fault, with s011 = 04, p001 = 04
04	err ov	Overvoltage
05	err pf	Cosφ Protection device
06	-	-
07	-	-
08	-	-
09	-	-
10	err cb	Communication error on RS485

8.2 RESETTING THE ERRORS AND PROTECTION DEVICES

Motor restart is always subject to clearing whatever caused the error.

In addition, if parameter **p013** = **00** the restart is only possible following a new "START" command; if you are in an operating mode that requires a constantly active start input (e.g. **s011** = **04**), you must deactivate and reactivate the start input in order to restart.

If parameter **p013** is set at a value between **1** and **200**, the automatic restart function will be enabled. In this case, the programmed value is the number of auto-reset attempts before a definitive lockout.

Parameter **p014** is the gap (in seconds) between one auto-reset attempt and the next.

Parameters from **d100** to **d105** contain a memory of the errors occurring. This memory can be reset via parameter **p018**.

8.3 PROTECTION DEVICE INTERVENTION

The intervention of any inverter protection device causes the motor to stop. If the ALS1 terminal is connected, the following information can be viewed:

- The number of errors occurring on each protection device.
- The codes of the last five errors.
- The "error in progress" condition and the error codes can also be acquired via Modbus.

The presence of the "2 static outputs" option, with the inverter suitably programmed, allows any current errors (or the absence of errors) to be signalled to external devices. The output function can only be programmed in relation to the error condition itself; no information about the type (code) of error can be obtained via the digital outputs.

The protection devices in the inverter are:

OVERTEMPERATURE: triggered when the temperature of the power module exceeds 80 °C. If it is triggered, make sure the Motoinverter is installed in a place with enough air flow to cool the outer container of the inverter.

	Attention: this protection device is not linked to the motor temperature (that can be controlled by means of an optional thermostitch fitted on at least one motor winding). In any case, excellent thermal motor protection is already guaranteed by the $\cos\phi$ control (see the explanation of the relative protection device below).
---	---

OVERCURRENT: triggered in the event of an instantaneous output overcurrent (on the motor).

OVERVOLTAGE: triggered when the voltage to the capacitor rises above the maximum permitted value. This condition may arise when sharp decelerations are applied with highly inertial loads. In this case, you must increase the deceleration time (via parameter **s004**).

It can also occur if the supply voltage is above the limit; in this case you must check whether the error occurs during a deceleration of the motor or when the motor is inactive or at a constant speed. By evaluating these conditions, it is possible to precisely identify the reason for the intervention of the device.

Cos ϕ PROTECTION DEVICE: linked to the true power factor measurement that the inverter makes on the motor at each moment. The standard parameters that the inverter uses to make the calculation ($\cos\phi$ 0.8 and integration time 8 minutes = 480 seconds) guarantee extremely effective protection against motor overheating in any working conditions. Any modification of parameters **p010** and **p011** is not generally recommended for resolving problems linked to the repeated intervention of this protection device; such problems must be resolved by ensuring auxiliary ventilation on the motor, otherwise the motor itself could burn. For further details, and any necessary optimisation of the protection device, please contact our Technical Service.

EXTERNAL FAULT: triggered following the activation of input IN4 when operating mode **s011** is set at a value of **04** and parameter **p001** is set at **04**. It can be used for any auxiliary function that must condition motor behaviour. When the input is activated, the inverter output is reset and the motor stops due to inertia.

COMMUNICATION ERROR ON RS485: triggered in the event of a time-out on the RS485 communication.

9. LOAD CURVE

At speeds below 600 rpm, torque derating should be taken into consideration for continuous services. Alternatively, request a motor with a powered fan. For more information contact our Technical Service.

Example of derating for load service S1

2-pole motor

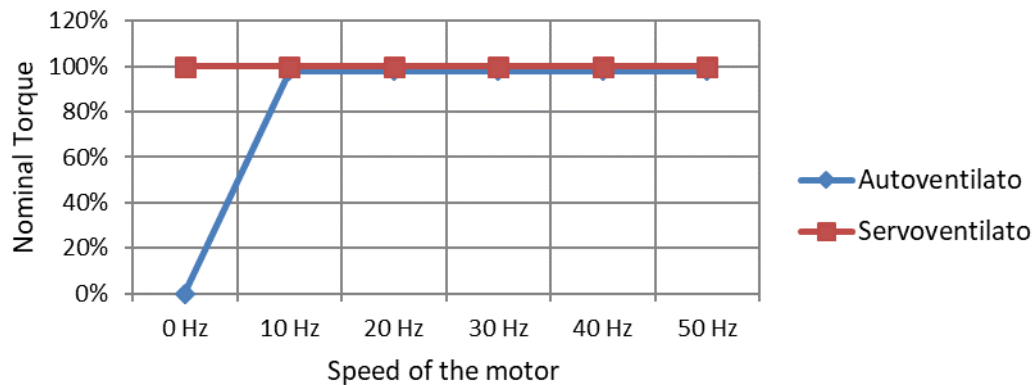

4-pole motor

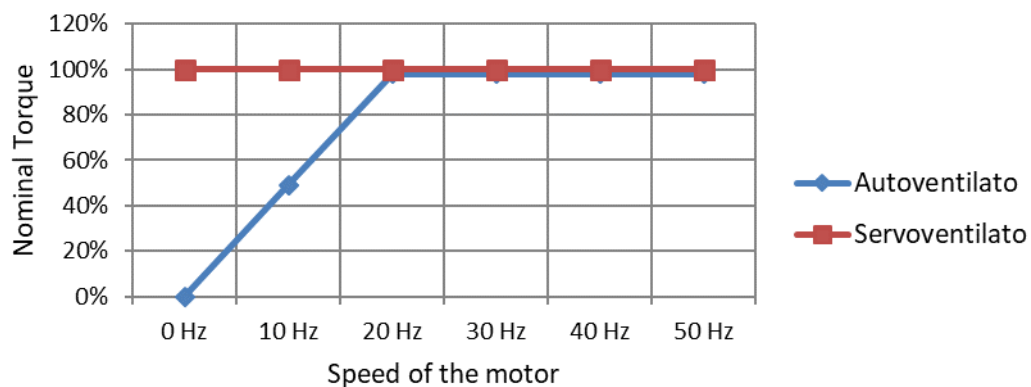

10. ACCESSORIES



Digital Programming Terminal



ALS1 adaptor cable for programming terminal



Remote Control Terminal



ALS2 adaptor cable for remote control terminal

11. DISPOSAL

Dispose of the electric motor according to the type of material and taking into account the regulations in force in the country of installation. Contact the manufacturer for further information on disposal methods.

The approximate weight of the motor's components is:

55% iron

30% copper

10% aluminum

5% inorganic.



Pursuant to Article 26 of Legislative Decree 14 March 2014, no. 49 "Implementation of Directive 2012/19/EU on Waste of Electrical And Electronic Equipment (WEEE)"

The symbol of the crossed bin on the equipment or on its packaging means that once the product reaches the end of its useful life it must be collected separately from other waste. The separate refuse collection of this equipment at the end of its life is organized and managed by the manufacturer.

The user who wishes to dispose of the equipment must therefore contact the manufacturer to receive instructions on the system used by same, in order to allow the separate collection of the equipment at the end of its service life.

Alternatively, concerning all equipment to be disposed of with sizes smaller than 25 cm, there is the possibility of handing it over to electronic product retailers, having a sales surface of at least 400 square meters, with no obligation to purchase new equivalent equipment.

An adequate separate collection, followed by recycling, treatment and disposal of the equipment at the end of its life, in a manner that is compatible with the environment, contributes to avoiding possible negative effects on the environment and health and promotes the reuse and/or recycling of the materials of which the equipment is made of.



Made in Italy EU



Legal Head Office: Via A. Fleming 6-8 | Operations & Logistics: Via A. Fleming, 10
40017 S. Giovanni in Persiceto (BO) Italy | Tel. +39 0516870911
info@nerimotori.com | www.nerimotori.com

REV.3 07/19
D-MRK-23_MANUALE NERIDRIVE EN